

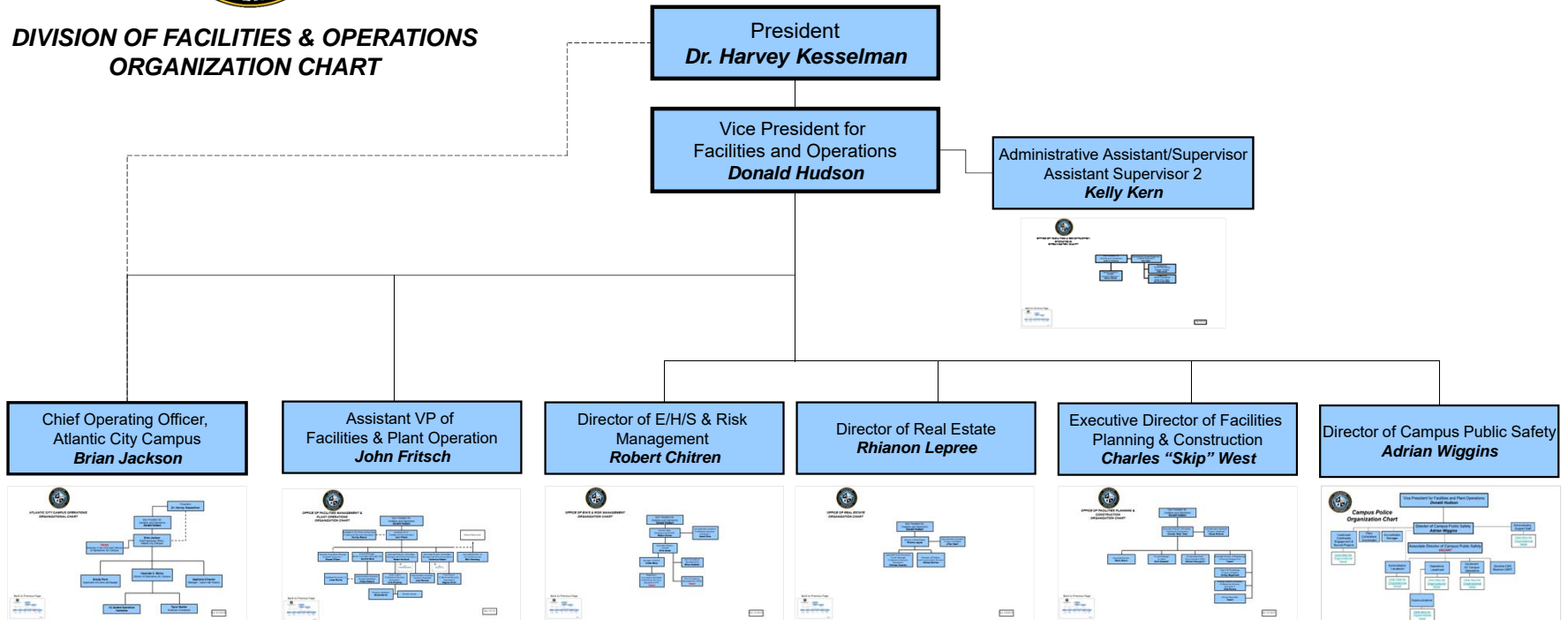

**DIVISION OF FACILITIES & OPERATIONS  
ORGANIZATION CHART**





**OFFICE OF FACILITIES & CONSTRUCTION  
OPERATIONS  
ORGANIZATION CHART**

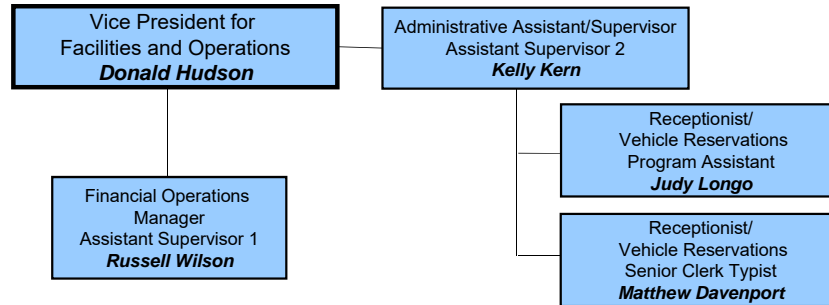

[Back to Previous Page](#)

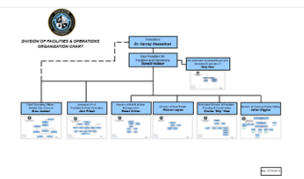

Rev 10/1/19



**OFFICE OF E/H/S & RISK MANAGEMENT  
ORGANIZATION CHART**

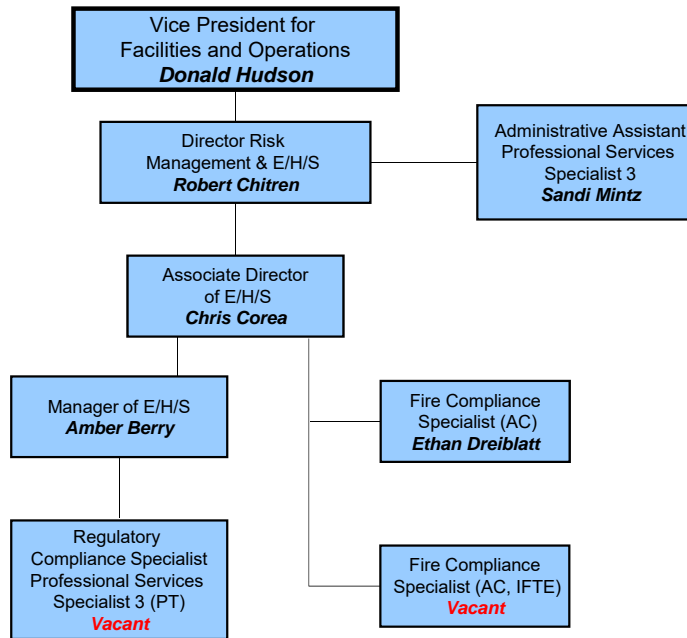

[Back to Previous Page](#)



**ATLANTIC CITY CAMPUS OPERATIONS  
ORGANIZATIONAL CHART**

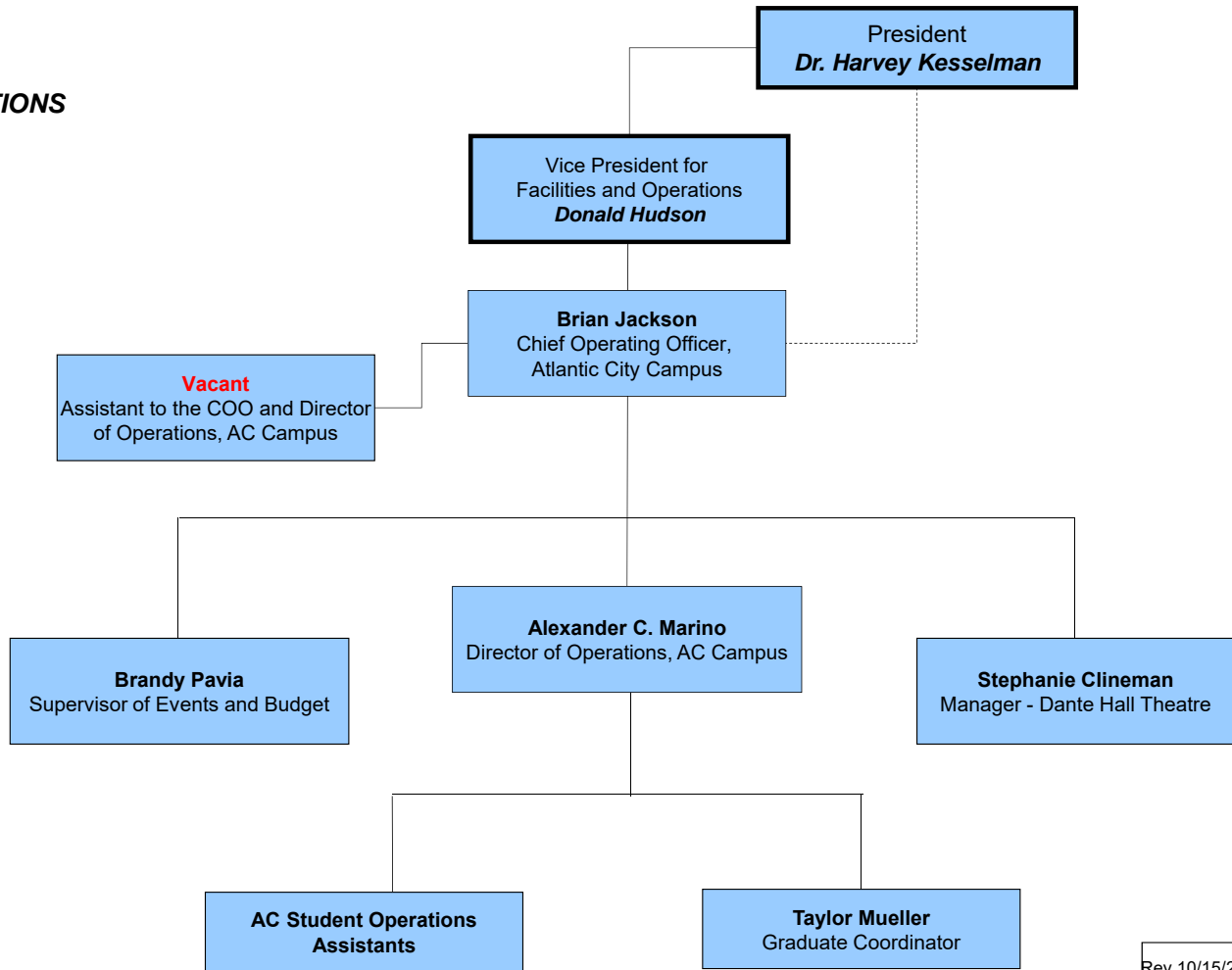

[Back to Previous Page](#)



Rev 10/15/2019



**OFFICE OF FACILITIES PLANNING & CONSTRUCTION  
ORGANIZATION CHART**

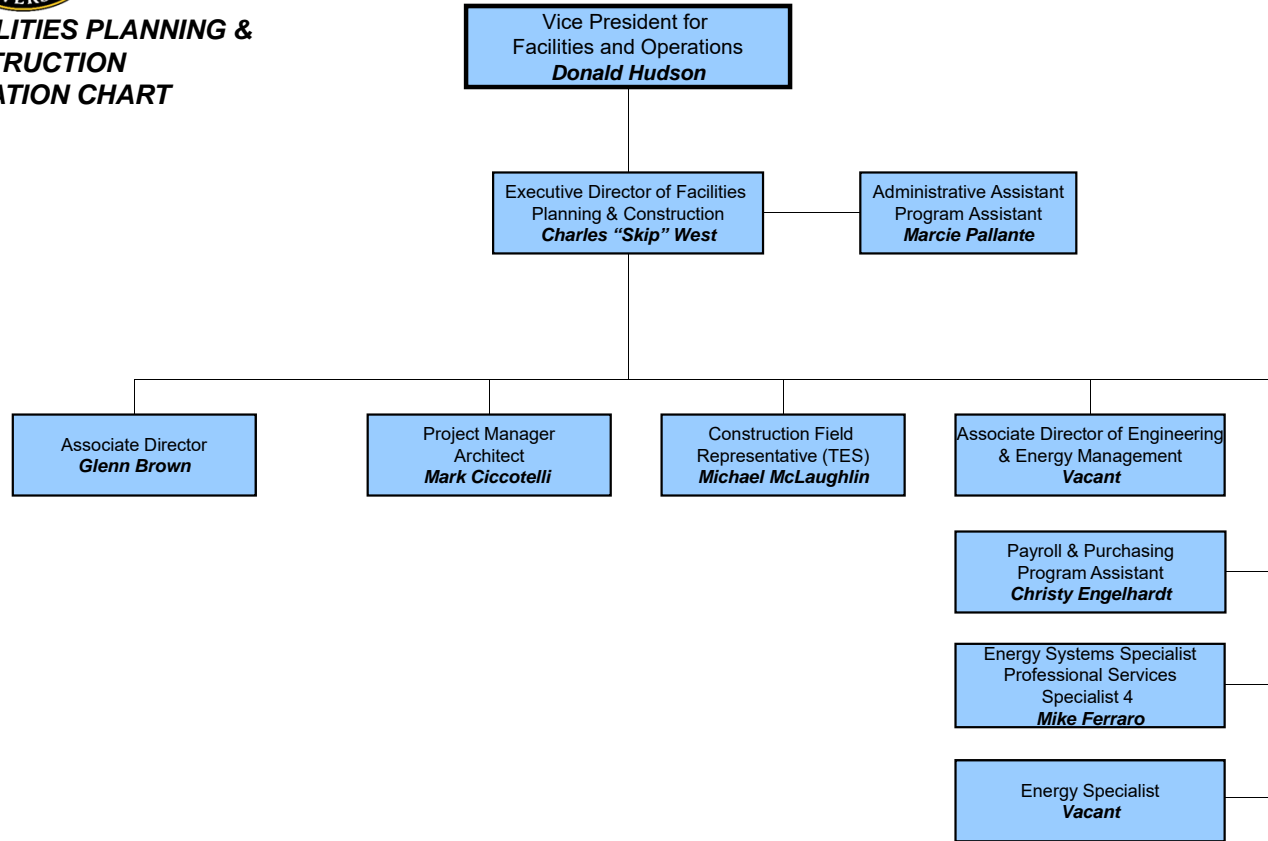

[Back to Previous Page](#)



**OFFICE OF REAL ESTATE  
ORGANIZATION CHART**

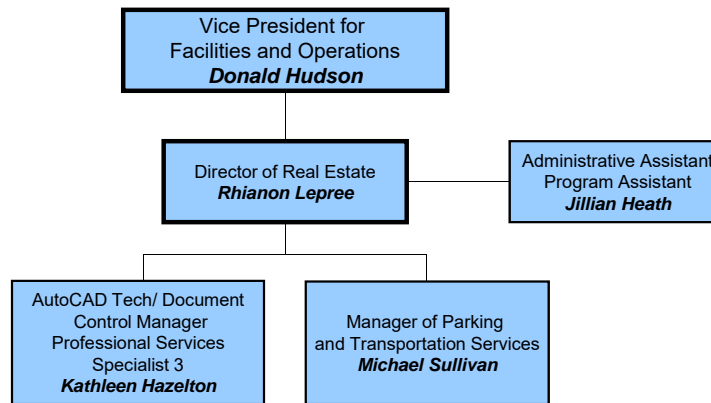

[Back to Previous Page](#)



Rev 10/9/2019



**OFFICE OF FACILITIES MANAGEMENT &  
PLANT OPERATIONS  
ORGANIZATION CHART**

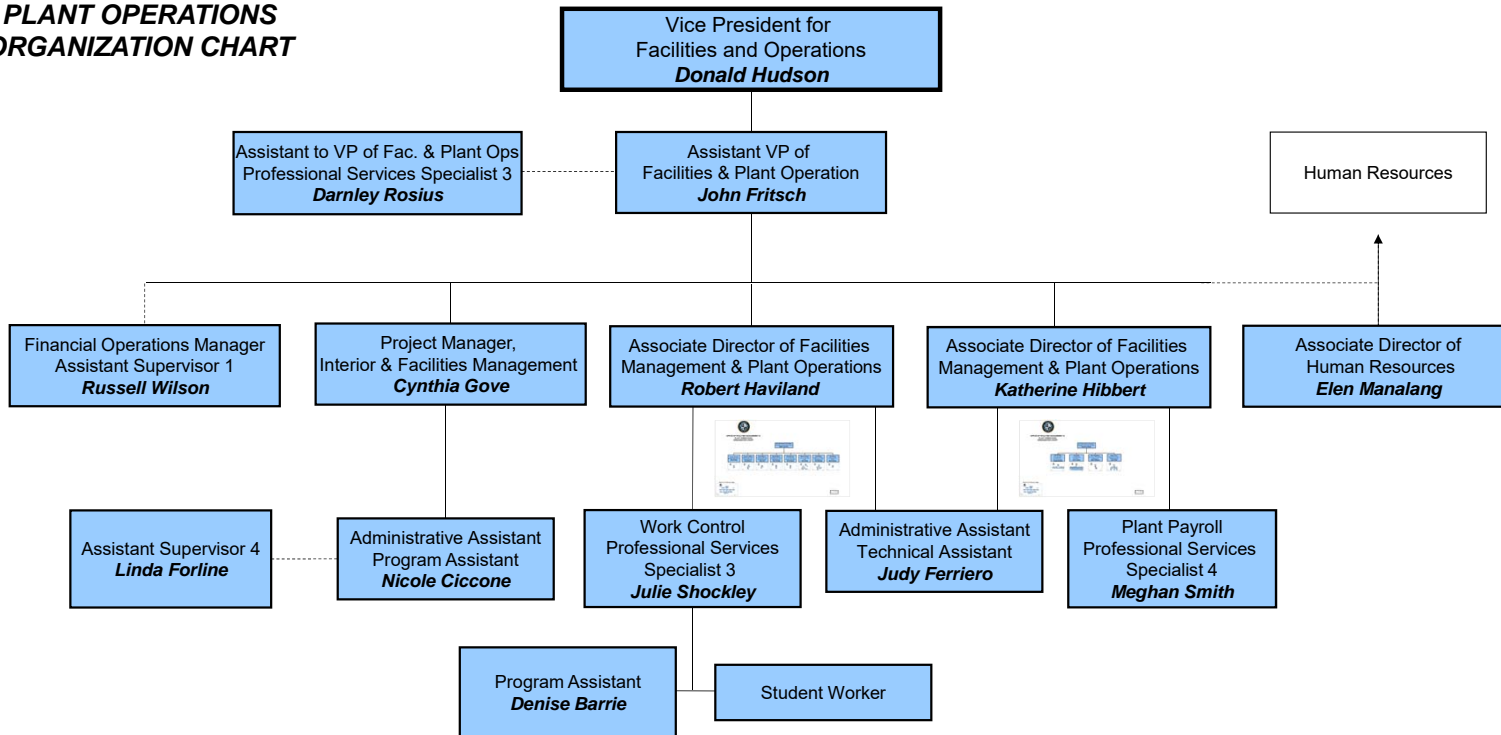

[Back to Previous Page](#)

Rev 10/1/19





**OFFICE OF FACILITIES MANAGEMENT &  
PLANT OPERATIONS  
ORGANIZATION CHART**

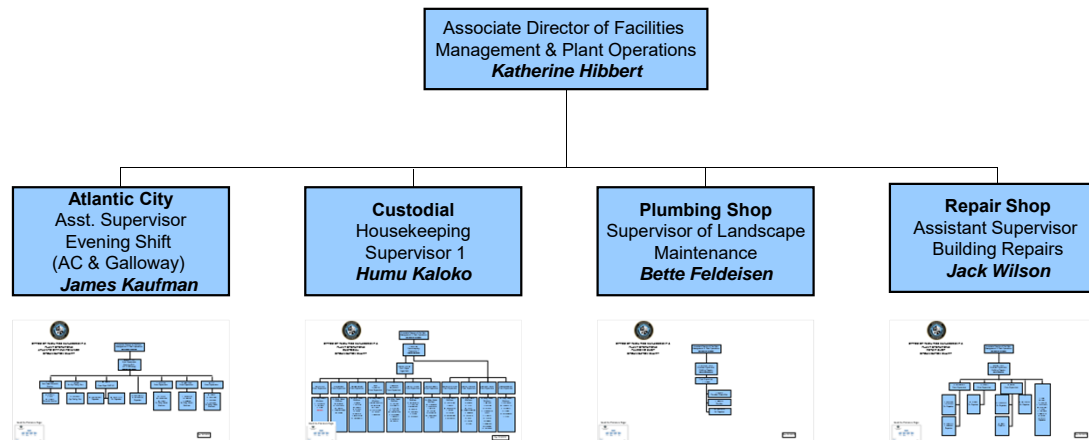

[Back to Previous Page](#)





**OFFICE OF FACILITIES MANAGEMENT &  
PLANT OPERATIONS  
ATLANTIC CITY MAINTENANCE  
ORGANIZATION CHART**

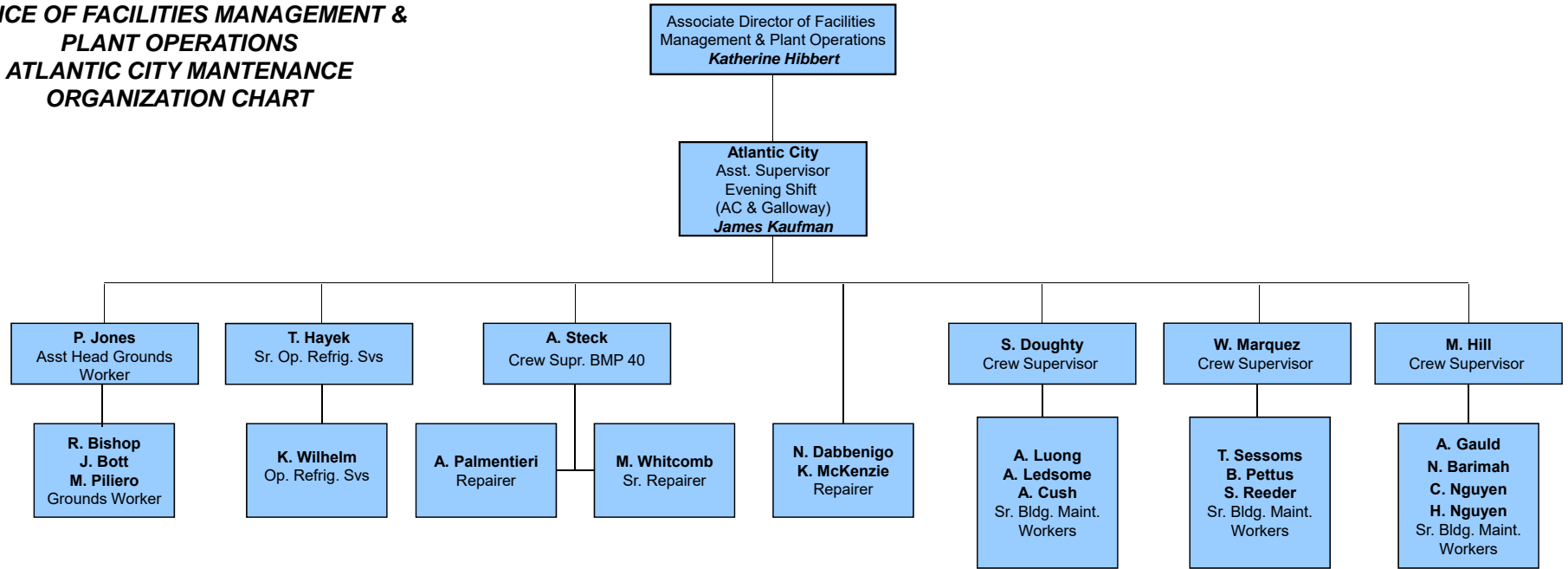

[Back to Previous Page](#)

Rev 10/12/2019



**OFFICE OF FACILITIES MANAGEMENT &  
PLANT OPERATIONS  
CUSTODIAL  
ORGANIZATION CHART**

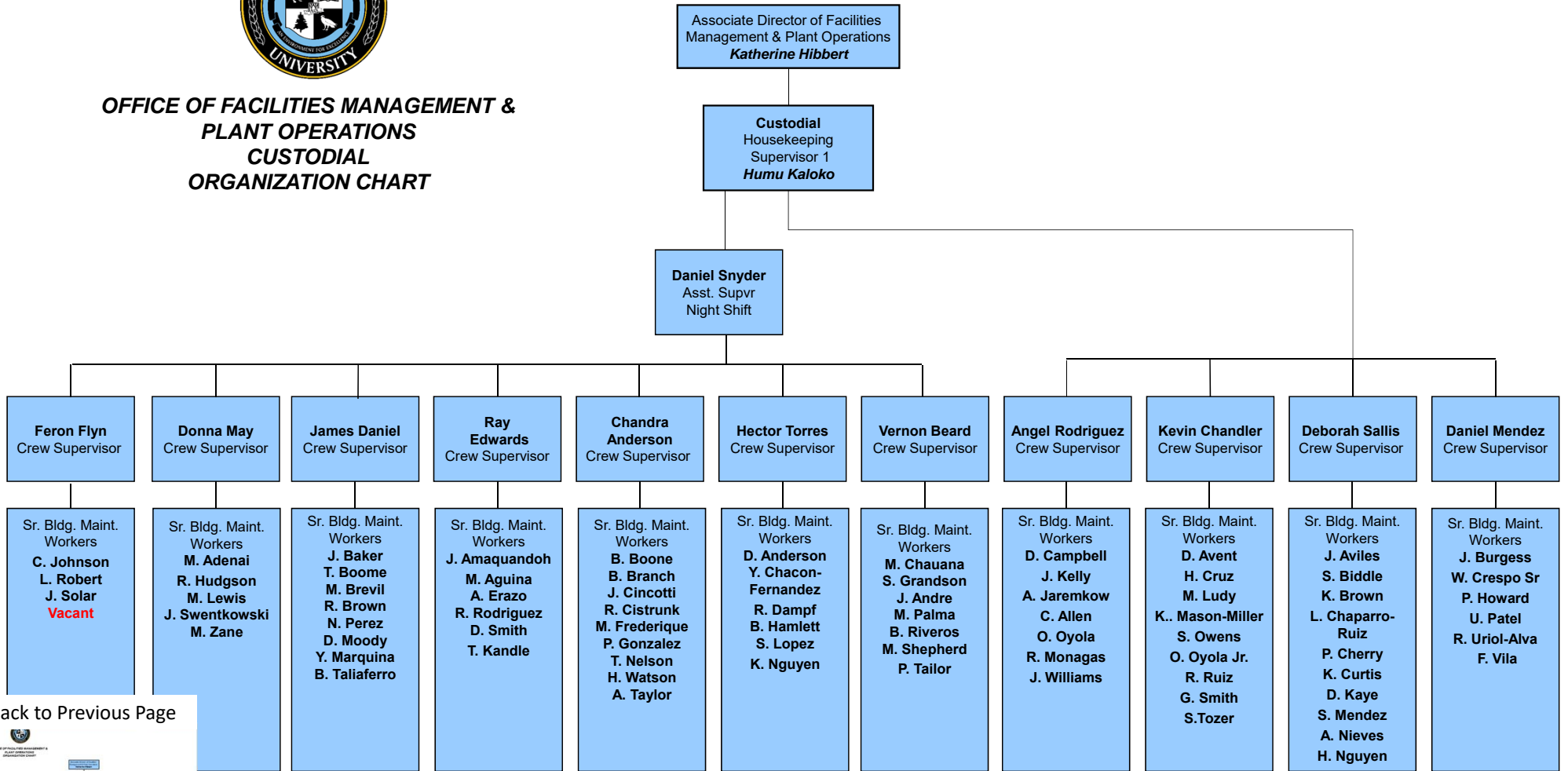

[Back to Previous Page](#)



**OFFICE OF FACILITIES MANAGEMENT &  
PLANT OPERATIONS  
PLUMBING SHOP  
ORGANIZATION CHART**

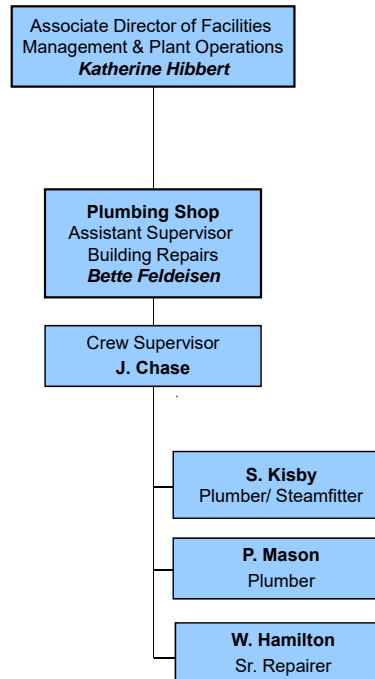

[Back to Previous Page](#)

Rev 10/1/2019



**OFFICE OF FACILITIES MANAGEMENT &  
PLANT OPERATIONS  
REPAIR SHOP  
ORGANIZATION CHART**

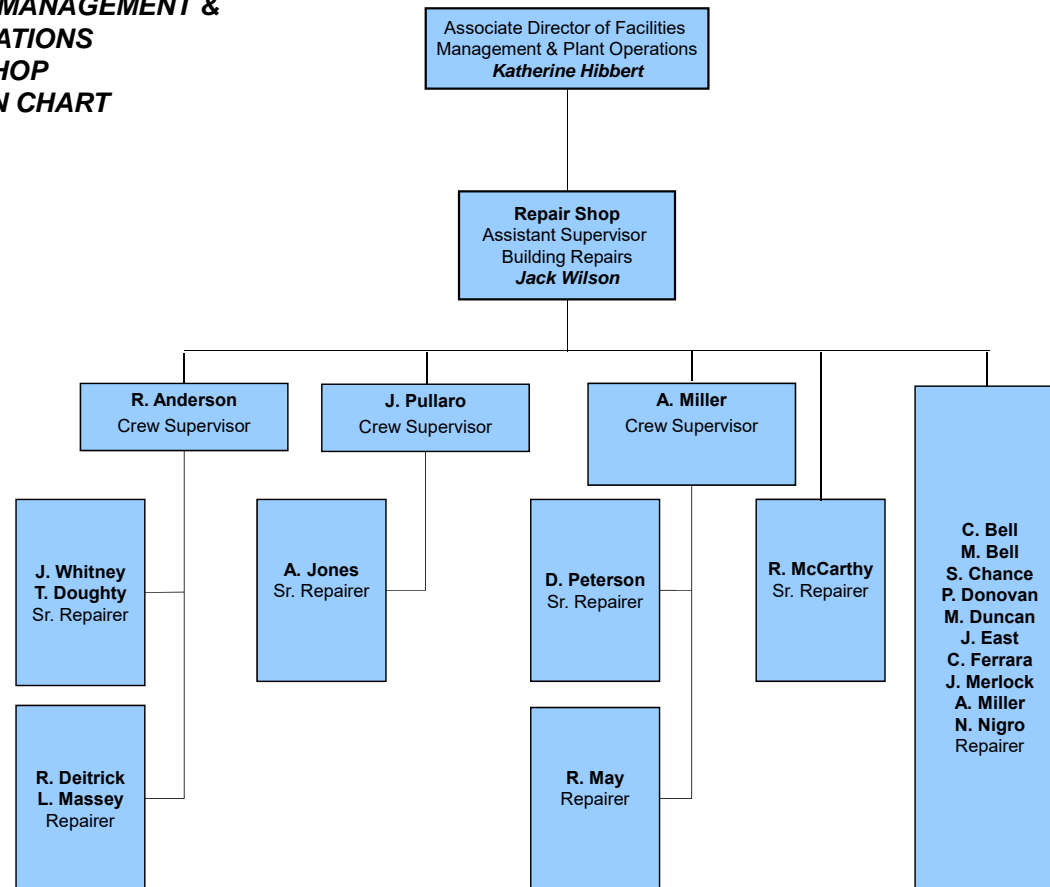

[Back to Previous Page](#)

Rev 10/1/2019





**OFFICE OF FACILITIES MANAGEMENT &  
PLANT OPERATIONS  
ACCESS CONTROL  
ORGANIZATION CHART**

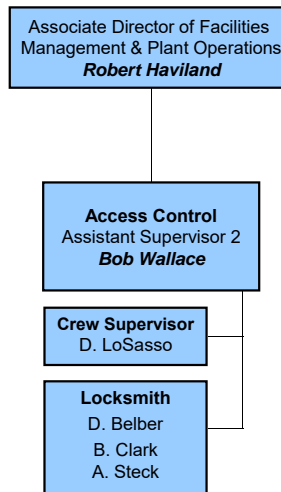

[Back to Previous Page](#)

Rev 10/1/2019



**OFFICE OF FACILITIES MANAGEMENT &  
PLANT OPERATIONS  
CARPENTER SHOP  
ORGANIZATION CHART**

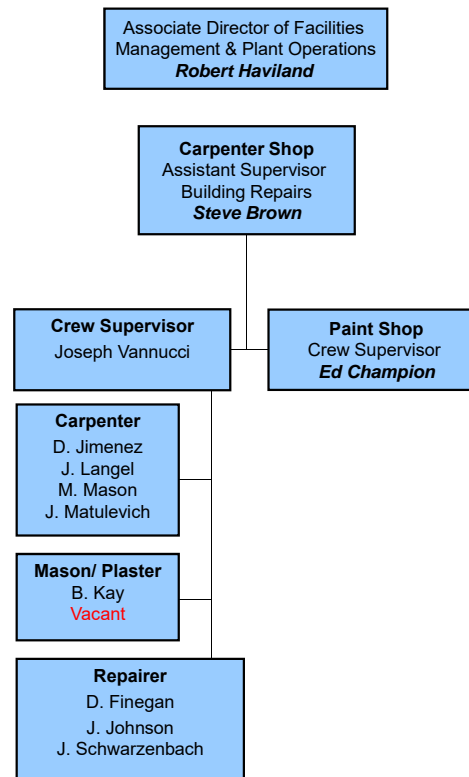

[Back to Previous Page](#)

Rev 10/1/2019



**OFFICE OF FACILITIES MANAGEMENT &  
PLANT OPERATIONS  
CENTRAL STORES  
ORGANIZATION CHART**

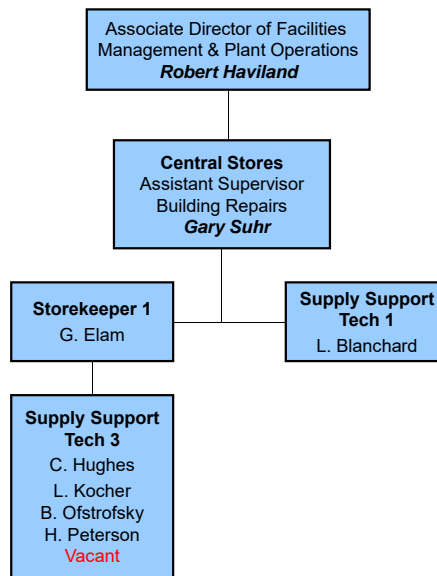

[Back to Previous Page](#)

Rev 10/1/2019





**OFFICE OF FACILITIES MANAGEMENT &  
PLANT OPERATIONS  
ELECTRIC SHOP  
ORGANIZATION CHART**

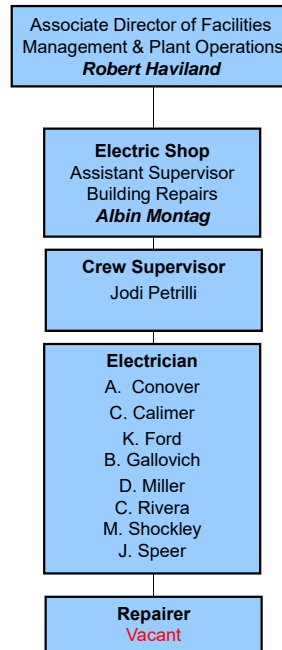

[Back to Previous Page](#)

Rev 10/1/2019



**OFFICE OF FACILITIES MANAGEMENT &  
PLANT OPERATIONS  
FLEET SERVICES  
ORGANIZATION CHART**

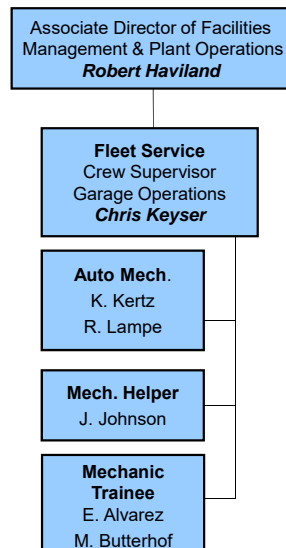

[Back to Previous Page](#)

Rev 10/1/2019



**OFFICE OF FACILITIES MANAGEMENT &  
PLANT OPERATIONS  
GROUNDS SHOP  
ORGANIZATION CHART**

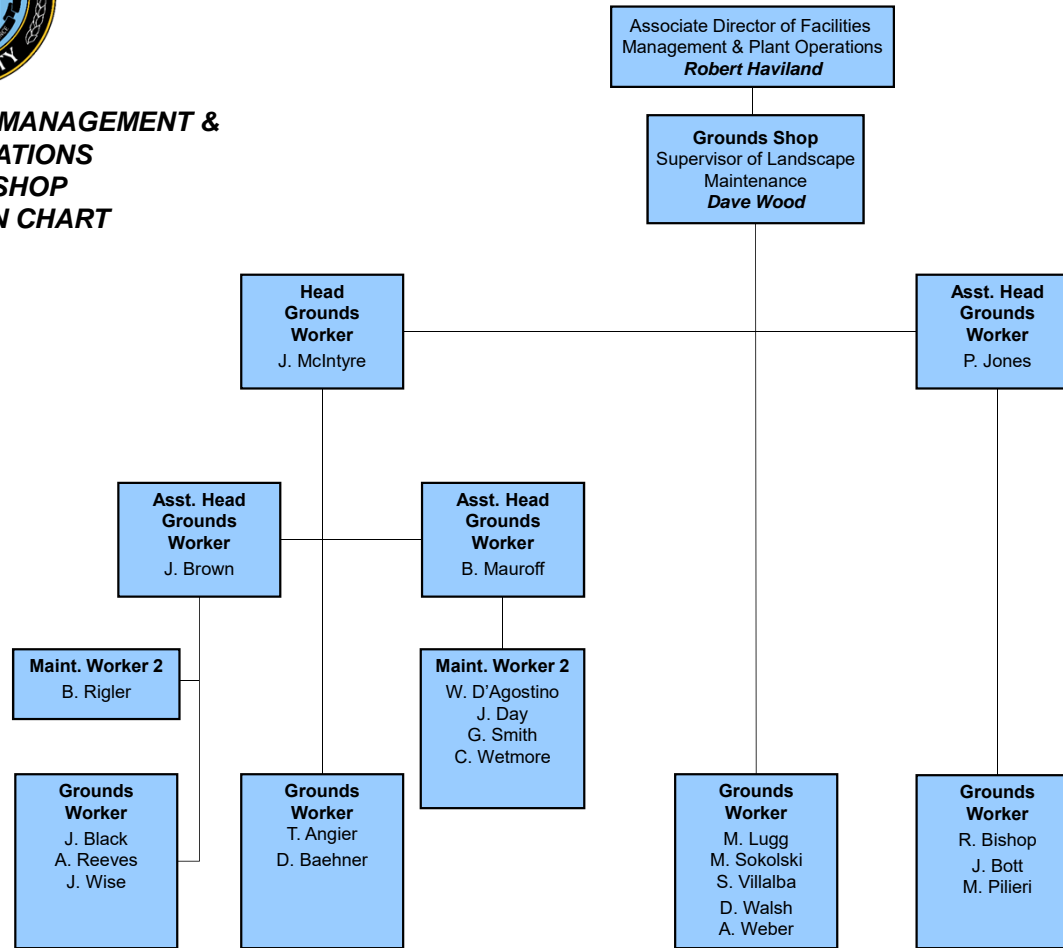

[Back to Previous Page](#)

Rev 10/1/2019

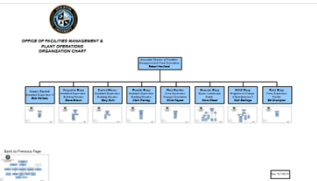



**OFFICE OF FACILITIES MANAGEMENT &  
PLANT OPERATIONS  
HVAC  
ORGANIZATION CHART**

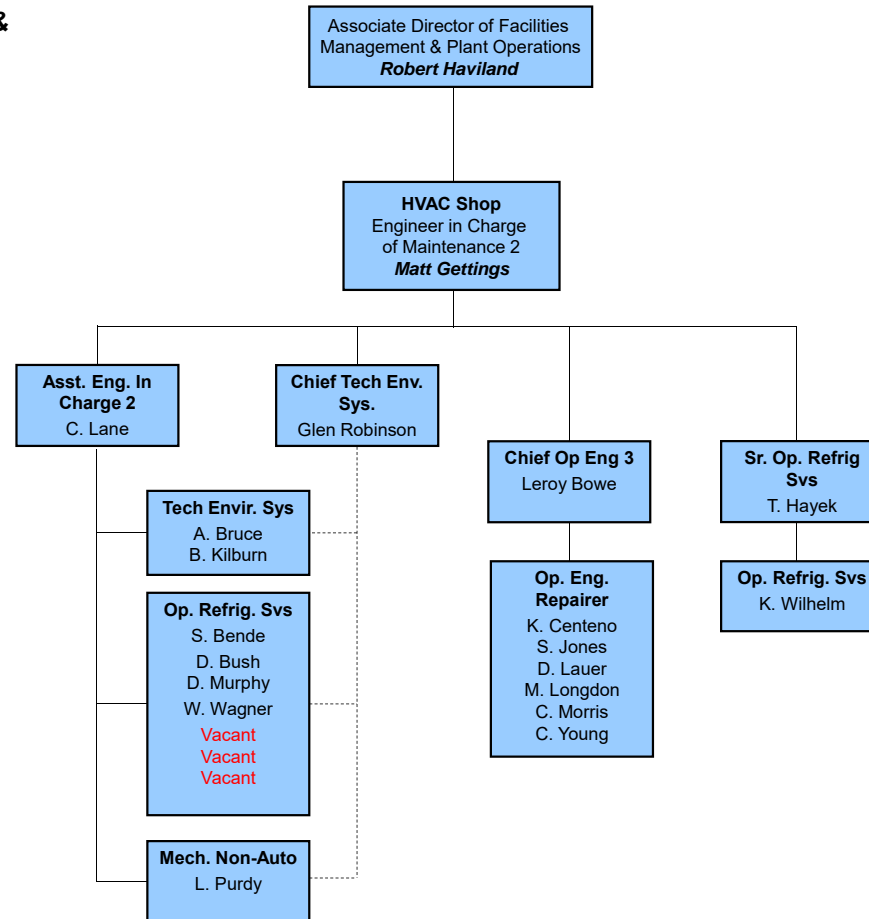

[Back to Previous Page](#)

Rev 10/15/2019

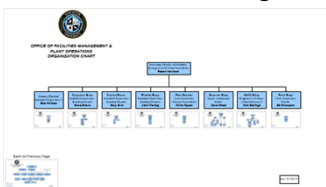



**OFFICE OF FACILITIES MANAGEMENT &  
PLANT OPERATIONS  
PAINT SHOP  
ORGANIZATION CHART**

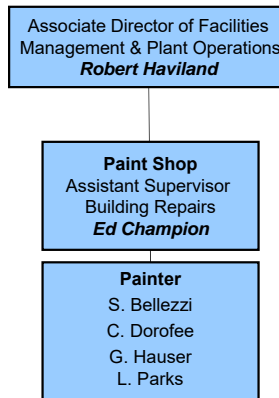

[Back to Previous Page](#)

Rev 10/1/2019